

Installation and Operation Guide

It's Under Control®

AD-8x

Audio Distribution System



Copyright © 2014
Remote Technologies Incorporated
All rights reserved.

FEDERAL COMMUNICATIONS COMMISSION NOTICE

This equipment has been tested and found to comply with the limits for a Class B digital device, pursuant to Part 15 of the FCC Rules. These limits are designed to provide reasonable protection against harmful interference in a residential installation. Any changes or modifications not expressly approved by the party responsible for compliance could void the user's authority to operate the device.

This equipment generates, uses, and can radiate radio frequency energy and, if not installed and used in accordance with the instructions, may cause harmful interference to radio communications. However, there is no guarantee that interference will not occur in a particular installation.

If this equipment does cause harmful interference to radio or television reception, which can be determined by turning the equipment off and on, the user is encouraged to try to correct the interference by one or more of the following measures:

- Reorient or relocate the receiving antenna.
- Increase the separation between the equipment and the receiver.
- Connect the equipment into an outlet on a circuit different from that to which the receiver is connected.
- Consult the dealer or an experienced radio/TV technician for help.

This device complies with Part 15 of the FCC Rules. Operation is subject to the following two conditions:

1. This device may not cause harmful interference.
2. This device must accept any interference received including interference that may cause undesired operation.



N27917

DECLARATION OF CONFORMITY (DOC)

The Declaration of Conformity for this product can be found on the RTI website at: www.rticorp.com/declaration

SAFETY SUGGESTIONS

Read Instructions. Read all safety and operating instructions before operating the unit.

Retain Instructions. Keep the safety and operating instructions for future reference.

Heed Warnings. Adhere to all warnings on the unit and in the operating instructions.

Follow Instructions. Install and operate in accordance with the manufacturer's instructions.

Accessories. Only use attachments/accessories specified by the manufacturer.

Portable Cart Warning. Use only with the cart, stand, tripod, bracket, or table specified by the manufacturer, or sold with the apparatus. When a cart is used, use caution when moving the cart/apparatus combination to avoid injury from tip-over.



Heat. Do not block any ventilation openings.

Heat. Keep the unit away from heat sources such as radiators, heat registers, stoves, etc., including amplifiers that produce heat.

Power. Unplug this apparatus during lightning storms or when unused for long periods of time.

Power Sources. Connect only to the power cord that was included with the unit.

Power Cord Protection. Route power supply cords so that they are not likely to be walked on or pinched by items placed on or against them, paying particular attention to the cords at plugs, at convenient receptacles, and at the point at which they exit from the unit.

Power Cord Grounding Plug. Do not remove the grounding prong of the grounding-type plug. A grounding type plug has two blades and a third grounding prong. The third prong is provided for your safety. If the provided plug does not fit into your outlet, consult an electrician for replacement of the obsolete outlet.

MAINS Outlet. Where MAINS outlets are used, the apparatus shall be connected to a MAINS socket outlet with a protective earthing connection.

MAINS Plug. Where the MAINS plug or an appliance coupler is used as the disconnect device, the disconnect device shall remain readily operable.

Water and Moisture. Do not use the unit near water—for example, near a sink, in a wet basement, near a swimming pool, near an open window, etc.

Object and Liquid Entry. Do not allow objects to fall or liquids to be spilled into the enclosure through openings.

Cleaning. Clean only with dry cloth.

Servicing. Do not attempt any service beyond that described in the operating instructions. Refer all other service needs to qualified service personnel.

Damage Requiring Service. The unit should be serviced by qualified service

SAFETY SUGGESTIONS

personnel when:

- Objects have fallen or liquid has been spilled into the unit.
- The power supply cord or the plug has been damaged.
- The unit does not appear to operate normally or exhibits a marked change in performance.
- The unit has been dropped or the enclosure has been damaged.

WARNING!

**TO REDUCE THE RISK OF FIRE OR ELECTRIC SHOCK,
DO NOT EXPOSE THE UNIT TO RAIN OR MOISTURE.**

LIMITED WARRANTY

Remote Technologies Incorporated warrants its products for a period of one (1) year from the date of purchase from Remote Technologies Incorporated or an authorized Remote Technologies Incorporated distributor.

This warranty may be enforced by the original purchaser and subsequent owners during the warranty period, so long as the original dated sales receipt or other proof of warranty coverage is presented when warranty service is required. Except as specified below, this warranty covers all defects in material and workmanship in this product. The following are not covered by the warranty:

Damage resulting from:

1. Accident, misuse, abuse, or neglect.
2. Failure to follow instructions contained in this Guide.
3. Repair or attempted repair by anyone other than Remote Technologies Incorporated.
4. Failure to perform recommended periodic maintenance.
5. Causes other than product defects, including lack of skill, competence or experience of user.
6. Shipment of this product (claims must be made to the carrier).
7. Being altered or which the serial number has been defaced, modified or removed.

Remote Technologies Incorporated is not liable for any damages caused by its products or for its failure of its products to perform, including any lost profits, lost savings, incidental damages, or consequential damages.

Remote Technologies Incorporated is not liable for damages based upon inconvenience, loss of use of the product, loss of time, interrupted operation, commercial loss, any claim made by a third party or made by you for a third party.

Remote Technologies Incorporated's liability for any defective product is limited to repair or replacement of the product, at our option.

If any component of your AD-8x Audio Distribution System needs service, please contact Remote Technologies Incorporated by telephone, fax or E-mail for return information. **Please do not return products to Remote Technologies Incorporated without return authorization.**

DISCLAIMER

All rights are reserved. No part of this document may be photocopied, reproduced, or translated without the prior written notice of Remote Technologies Incorporated.

The information contained in this document is subject to change without notice. Remote Technologies Incorporated shall not be liable for errors or omissions contained herein or for consequential damages in connection with the furnishing, performance, or use of this guide.

AD-8x, Integration Designer, and the RTI logo are registered trademarks of Remote Technologies Incorporated.

Other brands and their products are trademarks or registered trademarks of their respective holders.

iPod, iPod classic, iPod nano, and iPod touch are trademarks of Apple Inc., registered in the U.S. and other countries.

TABLE OF CONTENTS

Federal Communications Commission Notice.....	3
Safety Suggestions.....	4
Limited Warranty	6
Disclaimer	6
Table of Contents	7
Chapter 1 - Welcome	9
- Important Notes	9
- Product Contents	10
Chapter 2 - Features and Description	12
- Front Panel	13
- Rear Panel	14
- RSP-1 Remote Source Plate	16
- PDM-1 Phone/Doorbell Mute Panel.....	17
Chapter 3 - Installation and Operation	18
- Mounting	18
- Wiring and Connections	19
- Controlling the AD-8x	24
- Connection Diagram	26
- Configuration Using the Web Interface.....	28
Chapter 4 - Specifications.....	37
Chapter 5 - Troubleshooting.....	40
Chapter 6 - Service and Support.....	43
Index	45

CHAPTER 1 | WELCOME

Thank you for using the AD-8x Audio Distribution System.

With eight audio source inputs and eight zone outputs, wherever you go - the music moves with you. An integrated 16-channel amplifier provides plenty of power, while zone independent volume and tone control brings the sound to life. When you combine the AD-8x with RTI control processors, remote controls, touchpanels, and keypads, this RTI Audio Distribution solution easily keeps pace with the rhythm of your life.

The AD-8x audio distribution system is designed to be a seamless extension of an RTI control system. The AD-8x provides the audio switching, amplification and distribution functions, while RTI central processors and user interfaces manage the audio source control, user input and status feedback. Information such as the selected source, volume level, and tone control settings are available for each zone. Depending on the source equipment used, more advanced information such as song playlists, cover art, and tuner RDS data may also be available. Of course with RTI control systems, audio is just the beginning. Imagine every aspect of your environment working in complete harmony – from audio and video to lighting, ambience, temperature and more. Such scenarios are only made possible from an audio distribution system backed by a professional grade control system. Thanks to the efficient engineering that defines the AD-8x, there is no reason to limit yourself to a system that was designed only for music – with RTI so much more is possible.

IMPORTANT NOTES

Please read these important notes about the AD-8x:

- The AD-8x should be placed in an area where it is around normal room temperature (between 60°F to 90°F).
- Avoid installing the AD-8x in a location with little or no air circulation.
- Avoid installing the AD-8x in a location where it can come in contact with direct sunlight.
- Do not let the AD-8x system get wet. It should not be handled with wet hands or placed in an area where it could get wet.
- Do not subject the AD-8x to smoke, dust, or vibrations.
- Only use the power cord that is supplied with the AD-8x. Using the wrong type of power cord may result in damage.
- Do not disassemble the unit. Service of the AD-8x should be performed by authorized personnel only.

CHAPTER 1 | PRODUCT CONTENTS

Contents within the box include the following items:

- One (1) AD-8x Audio Distribution System
- One (1) AD-8x Faceplate
- Eight (8) Four Position Phoenix Connectors
- Two (2) Rack Mounting Ears with Screws
- One (1) Power Cord
- One (1) Installation Guide

UNPACKING AND INSPECTION

After unpacking your new AD-8x Audio Distribution System, save all of the packing materials in case you ever have to ship the unit.

Thoroughly inspect the AD-8x and packing materials for signs of damage. Report any damage to the carrier immediately. Report any equipment malfunctions to RTI or an authorized RTI distributor.

CHAPTER 2 | FEATURES AND DESCRIPTION

The AD-8x provides superior quality and reliability as well as these specific features:

- Eight amplified stereo audio output zones (either 4 ohm or 8 ohm speakers may be connected to the zone outputs).
- Eight analog audio source inputs - Eight local inputs which may be augmented with four remote source inputs using accessory wall plate (RSP-1).
- Audio input trim adjustment on each source.
- Cool Power® class-D amplifier provides twenty-five watts per channel.
- Amplifier offers thermal and short-circuit protection.
- Pre-outputs in each zone allow external amplification for additional power or speakers in a zone.
- Independent volume and tone control for all audio zones.
- Built-in web interface provides output zone configuration and testing.
- Controlled via IP, RS-232 or Infrared.
- Optional phone and doorbell mute accessory.
- Zone power indicator LEDs.
- Rack mountable (3U rack form factor) or free standing.
- As many as eight AD-8x units may be source-looped, for distributing audio sources up to 64 zones.

CHAPTER 2 | FEATURES AND DESCRIPTION

AD-8X FRONT PANEL

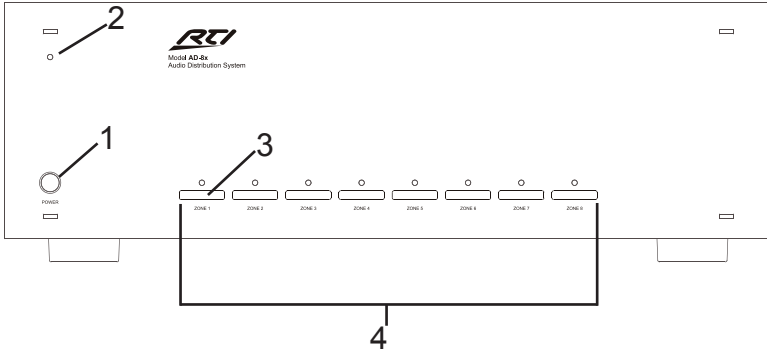

1. Power Switch

Turns AD-8x power on or off. During normal use, this switch will remain on at all times.

2. Power LED

A blue LED will be lit up when power is on.

3. Zone Power LED

A red LED indicates that the corresponding zone is on when lit.

4. Zone Label area

Area for placement of a zone name labels (not included).

CHAPTER 2 | FEATURES AND DESCRIPTION

AD-8x REAR PANEL QUICK REFERENCE

NOTE: See Chapter 3 for full description and connection details.

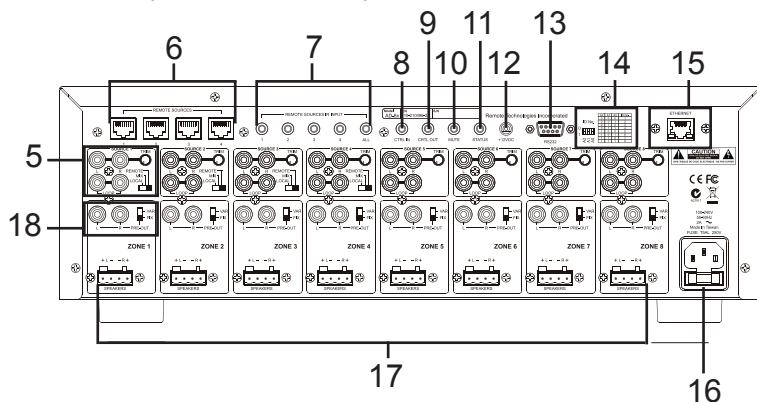

5. Source Inputs - Loop Outputs - Trim Control - Input Switch

- **Source Inputs:** Eight stereo RCA inputs (Left/Right channels) for audio signal input from audio sources (tuner, music server, satellite radio etc.).
- **Loop Outputs:** These buffered loop outputs allow each source to be distributed to multiple AD-8x systems if more than 8 output zones are required.
- **Trim Control** - The Trim Control dials on the AD-8x are used to equalize signal levels of each input source to ensure that switching between inputs will result in the same output level.
- **Input Switch - Remote/Mix/Local** - This switch determines which input source will be used (Local or Remote).

6. Remote Source Inputs

RJ-45 jacks for connection of up to four RTI RSP-1 Remote Source wall plates (sold separately) for audio sources located remotely (iPod® dock, CD player, PC, etc.).

7. Remote Source IR Inputs

These 3.5mm mono jack inputs allow the connection of an IR output port from an RTI control system to a remote audio source for control.

8. CTRL IN - IR Input

This 3.5mm mono mini-jack is for infrared control of the AD-8x from a control system.

9. CTRL OUT - IR Pass through

This 3.5mm mono mini-jack allows IR to "pass through" from the CTRL IN port, for infrared control of additional AD-8x units from a control system.

10. Mute

This 3.5mm stereo mini-jack is for the connection of an RTI PDM-1 Phone/Doorbell Mute Module (sold separately). The PDM-1 mutes the AD-8x audio outputs when a phone/doorbell system sends a voltage to the PDM-1 which triggers a circuit closure that is sensed by the Mute input.

CHAPTER 2 | FEATURES AND DESCRIPTION

AD-8X REAR PANEL QUICK REFERENCE

11. Status

This 3.5mm mono connection provides a +12VDC output when any zone is turned on (15mA max). This can be used to trigger external equipment. When all zones are turned off, 0VDC is present.

12. +12VDC

This 3.5mm mono connection provides a constant +12VDC output (500mA max).

13. RS-232

DB-9 jack for RS-232 control of the AD-8x from a control system.

14. ID Number

Installations can have up to 8 AD-8x units installed providing up to 64 output zones. Each AD-8x can have a unique ID number to allow discrete IR control. Discrete IR code libraries are available for each unique ID. Refer to the ID assignment chart to the right of the 3 switches and adjust as necessary to set the unique ID for each AD-8x unit.

15. Ethernet Port

The Ethernet port (RJ45) allows for bi-directional control from an RTI XP series control processor over an Ethernet network (LAN). A two-way driver is available on the RTI website (dealer section) that will enable this type of control.

16. AC Power Socket and Fuse

A three-pin grounded socket that connects with a removable AC power cord with a T5AL 250V fuse.

IMPORTANT POWER NOTICE

This product is shipped from RTI with AC voltage set to 115 Volts. The voltage switch will have to be changed for certain international locations. Dealers should take the following critical step.

- **Set the red voltage switch on the bottom of the AD-8x to the proper voltage for your location (115V/230V)**
- **The red voltage switch should be left in the 115 Volt position if used within the United States.**

17. Speaker Outputs

Eight sets of removable Phoenix connectors for wiring to speakers in each zone. Either 4 ohm or 8 ohm speakers may be connected.

NOTE: Connected speakers must have a 4 ohm minimum load or damage to the unit may occur.

18. PRE-OUT Outputs

Provides line level audio outputs for driving external amplifiers, such as the RTI CP-450 or CP-1650 amplifiers. The switch can be set to VAR or FIX.

- **VAR** - The output level is variable and will ramp up and down with the corresponding AD-8x zone volume control.
- **FIX** - The output level is fixed and is not affected by the corresponding AD-8x zone volume control. **Using this setting requires an external amplifier which supports volume control.**

CHAPTER 2 | FEATURES AND DESCRIPTION

RSP-1* REMOTE SOURCE PLATE - FRONT

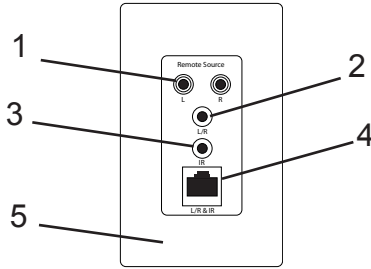

1. Audio Inputs - RCA

Two RCA input jacks for connection to the output (left and right) of the remote audio source (Apple iPod®, Satellite Tuner etc).

2. Audio Inputs - 3.5mm

One 3.5mm stereo mini jack for connection to the output of the remote audio source (iPod®, PC etc).

3. IR Output

One 3.5mm mono mini jack for connection of an IR emitter to control the remote source from a control system.

4. Audio Inputs and IR Output

Note: Normally, this connection would not be used.

This RJ-45 connection carries the left and right audio inputs from the remote source and the IR control output over cat-5 cable.

5. Decora® faceplate (not included)

Compatible with standard single-gang Decora® style faceplates.

RSP-1* REMOTE SOURCE PANEL - REAR

6. Mounting holes

Use screws to mount the RSP-1 in a standard single-gang electrical box.

7. Audio and IR control - RJ-45

This RJ-45 connection carries the left and right audio inputs from the remote source and the IR control output between the AD-8x and the remote source.

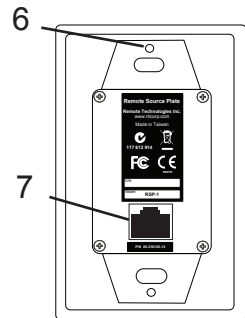

*Note: RSP-1 sold separately.

CHAPTER 2 | FEATURES AND DESCRIPTION

PDM-1* PHONE/DOORBELL MUTE PLATE - FRONT

The back panel of the AD-8x has a 3.5mm stereo connector input labeled "Mute". This is designed to be used with the PDM-1 Phone/Doorbell Mute module. When the PDM-1 is installed, the system will temporarily mute when the phone or doorbell rings.

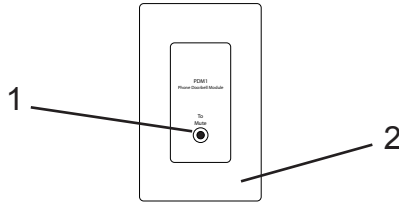

1. Phone - Doorbell Output - 3.5mm

This 3.5mm stereo mini jack is for connecting to the "Mute" connection on the rear panel of the AD-8x. (See the AD-8x rear panel description)

2. Decora® faceplate (not included)

Compatible with standard single-gang Decora® style faceplates.

PDM-1 PHONE-DOORBELL MUTE MODULE - REAR

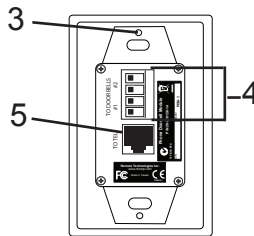

3. Mounting holes

Use screws to mount the PDM-1 in a standard single-gang electrical box.

4. Doorbell Connectors

The PDM-1 Phoenix connector will accept up to two AC or DC voltages from two different doorbell chimes. This connection is done with two conductor wire from the terminals on the doorbell chime to the Doorbell 1 or Doorbell 2 inputs on the back of the PDM-1. Polarity is not important for this connection.

5. Phone System - RJ-11

A single phone line can be brought into the RJ-11 connection on the back of the PDM-1. The ring voltage from the phone line will trigger the AD-8x system to mute.

*Note: PDM-1 sold separately.

CHAPTER 3 | INSTALLATION AND OPERATION

FREE STANDING INSTALLATION

The AD-8x ships with four removable feet that allow the AD-8x to be placed on a flat surface. To maintain proper ventilation and cooling, do not install the AD-8x on a flat surface without the feet.

RACK MOUNT INSTALLATION

The AD-8x can be mounted in a component rack using the included rack mounting ears. Align the rack mounting ears with the screw holes located on the sides of the AD-8x near the front. Fasten the rack ears to the AD-8x using three screws (supplied). Remove feet before mounting in a rack.

NOTE: To maintain proper ventilation, it is recommended that you leave a rack space above and below the AD-8x.

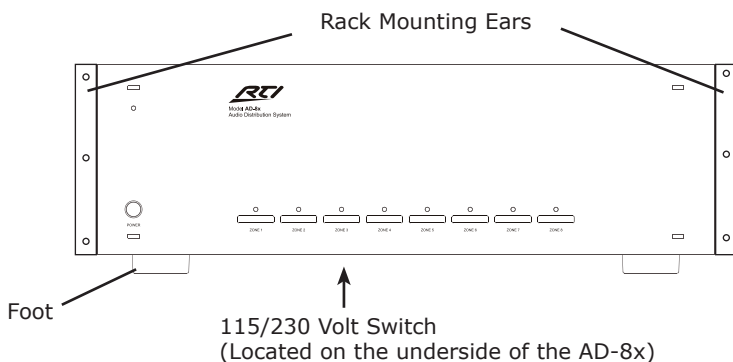

POWER

The included AC power cord must be inserted into the AC input receptacle on the AD-8x. When the AC power cord is connected to a power source, press the Power button to turn the AD-8x on and off.

IMPORTANT NOTICE

This product is shipped from RTI with AC voltage set to 115 Volts. The voltage switch will have to be changed for certain international locations. Dealers should take the following critical step.

- **Set the red voltage switch on the bottom of the AD-8x to the proper voltage for your location (115V/230V)**
- **The red voltage switch should be left in the 115 Volt position if used within the United States.**

CHAPTER 3 | INSTALLATION AND OPERATION

SPEAKER WIRE TERMINATION

Install the eight supplied Phoenix connectors into the audio zone outputs on the AD-8x. Connect the positive and negative wires for each audio channel output, keeping the proper orientation of positive and negative signal for each speaker connection. Typically, two-conductor speaker wire uses red to denote positive and black to denote negative. Four-conductor wire can also be used. This has four separated wires in one outer jacket, making it possible to run a single speaker wire to a zone for its pair of speakers. This type of wire typically uses red and black for one speaker and white and green as positive and negative for the second speaker.

CAUTION: Do not short speaker wires together if they are connected to the AD-8x, as damage to the unit may result.

CONNECTING LOCAL AUDIO SOURCES

The AD-8x has eight sets of RCA audio inputs for connecting up to eight sources.

- Trim Control:** The Trim Control dials on the AD-8x are used to equalize signal levels of each input source to ensure that switching between inputs will result in the same output level. The Trim Control is initially set at zero (no attenuation).
 NOTE: Adjusting the Trim Control dial will adjust the signal level of both the local source input and remote source input simultaneously. Thereby adjusting the output supplied to the Pre-Out jacks set in either FIX or VAR mode and to the speaker jacks.
- Local/Mix/Remote Switch:** This switch determines which input source will be used (Local or Remote).
 NOTE (Mix Mode): While it is possible to have audio sources wired to both the local and remote inputs, and the input switch set to "Mix", it is important that both sources (local and remote) not be "on" at the same time otherwise the signal will be blended.
- Loop Outputs:** These buffered loop outputs allow each source to be distributed to multiple AD-8x systems if more than 8 output zones are required.

AD-8x Local Source Inputs

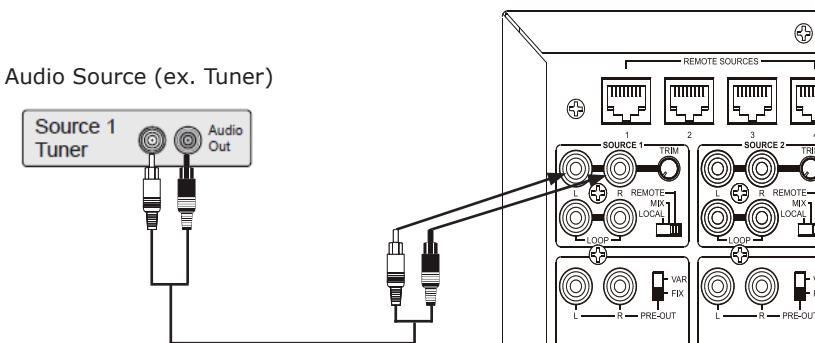

CHAPTER 3 | INSTALLATION AND OPERATION

WIRING FOR REMOTE AUDIO SOURCES

RSP-1 Remote Source wall plates installed in locations where the audio sources will be used and are wired back to the AD-8x

Use standard Cat-5 cable between the RSP-1 Remote Source Plate and the RJ-45 jacks on the rear of the AD-8x. The RSP-1 has stereo RCA jacks and a 3.5mm mini stereo jack for connecting to the output of the audio source.

In addition to carrying the audio signals, the Cat-5 cable between the RSP-1 and AD-8x carries IR control of the remote source from an RTI control system. The control system delivers IR commands to the 3.5mm IR inputs on the rear of the AD-8x.

NOTE: The AD-8x can accommodate 500 total feet of Cat-5 cable for each zone. For the most reliable operation, it is best that no single run of Cat-5 exceeds 250 feet. The correct wiring scheme for the Cat-5 cable is standard EIA/TIA 568B.

CONTROLLING REMOTE AUDIO SOURCES

Remote audio sources can be controlled via infrared control delivered over the same Cat-5 cable wired to the RSP-1 Remote Source Panel that is used for the audio signal. The IR commands used to control the sources come from an RTI control system which is wired to the IR inputs located on the rear of the AD-8x. Each remote source has an IR input for independent control of that remote source. The "All" input on the AD-8x provides IR control of all remote sources when discrete control is not required.

CHAPTER 3 | INSTALLATION AND OPERATION

CONNECTING REMOTE AUDIO SOURCES

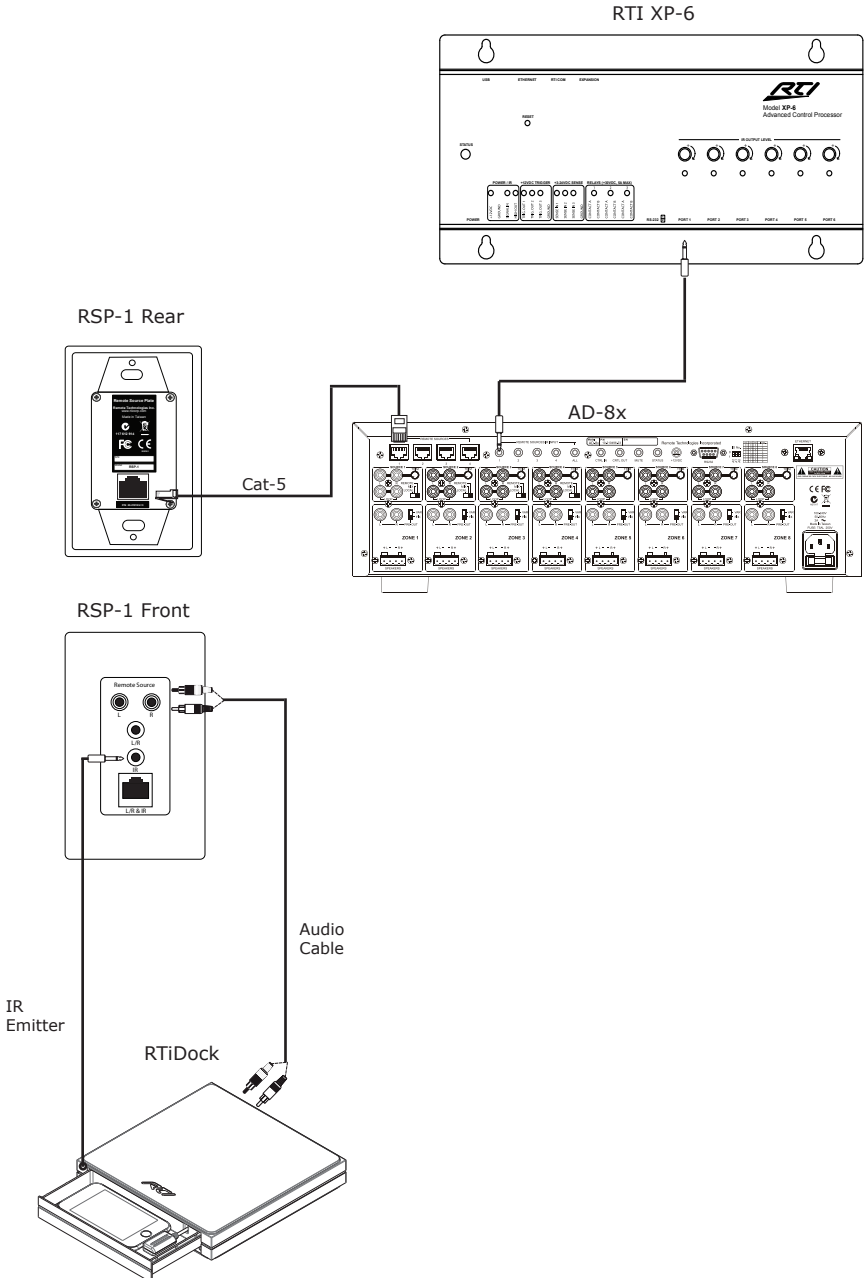

CHAPTER 3 | INSTALLATION AND OPERATION

CASCADING MULTIPLE AD-8X UNITS

It is possible to expand the number of output zones by cascading up to eight AD-8x Audio Distribution Systems together. This allows audio from up to eight sources to be distributed to as many as 64 zones.

NOTE: In order to control multiple AD-8x units using IR commands, each AD-8x must have a unique ID number. Set the ID by using the 3 switches and ID assignment grid on the rear of each unit. Control via RS-232 and IP do not require this step.

Source Cabling to Multiple AD-8x - Loop Outs

The loop output connections allow sources to be extended to the source input on additional AD-8x units.

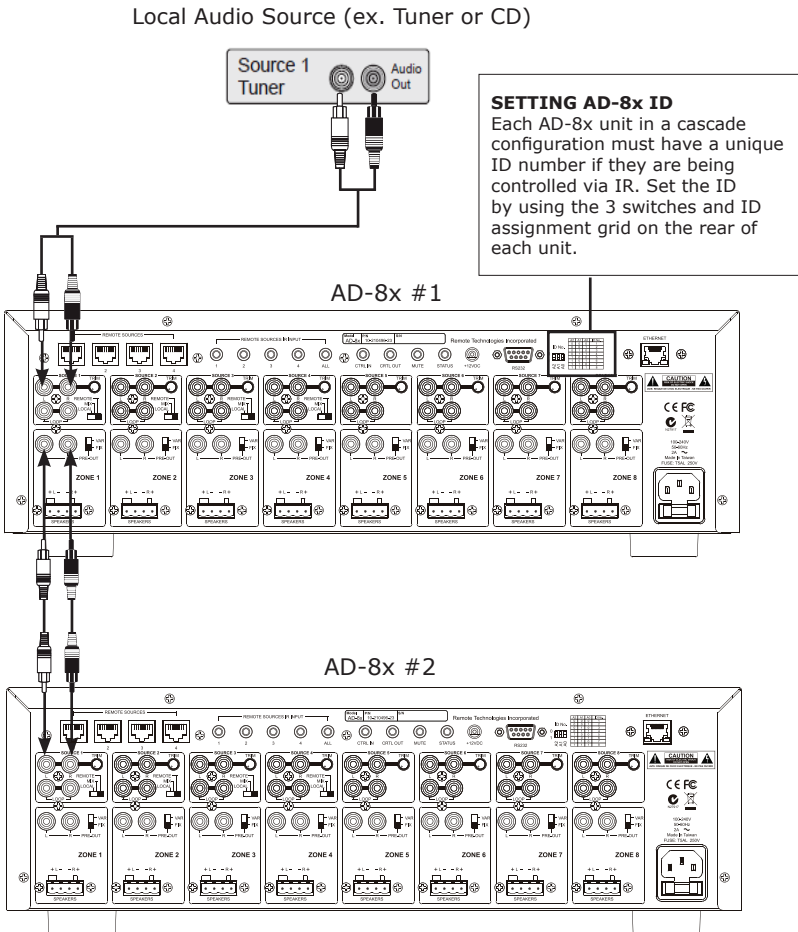

CHAPTER 3 | INSTALLATION AND OPERATION

WIRING FOR MUTE INPUT

The back panel of the AD-8x has a 3.5mm non-shorting stereo connector input labeled "Mute". This is designed to be used with the PDM-1 Phone-Doorbell-Mute module. When the PDM-1 is connected, the system will temporarily mute when the phone or doorbell rings.

Doorbell

The back of PDM-1 will accept up to two AC or DC voltages from two different doorbell chimes. This connection is done with two conductor wire from the terminals on the doorbell chime to the Doorbell A or Doorbell B inputs on the back of the PDM-1. Polarity is not important for this connection.

Telephone Muting

The ring voltage from a phone line will trigger the AD-8x system to mute.

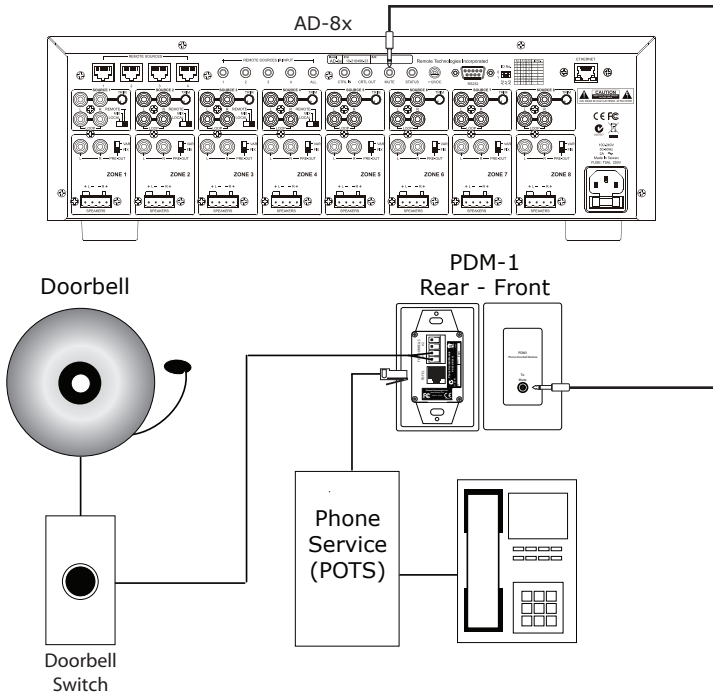

CHAPTER 3 | INSTALLATION AND OPERATION

IR CONTROL OF AD-8x - CTRL IN

This 3.5mm mono mini-jack is for infrared control of the AD-8x from a control system. A discrete set of IR codes is available within the RTI Integration Designer programming software or on the RTI website (RTI dealer section).

NOTE: Mini-jack is mono with tip = IR+, ring=Gnd.

IR PASSTHROUGH TO CONTROL ADDITIONAL AD-8x - CTRL OUT

This 3.5mm mono mini-jack allows IR to "pass through" from the CTRL IN port, for infrared control of additional AD-8x units from a control system.

RS-232 CONTROL OF AD-8x

A DB-9 jack offers RS-232 control of the AD-8x from an RTI or third-party control system. A set of RS-232 codes is built into the Integration Designer programming software and a two-way driver is available on the RTI website (dealer section).

NOTE: DO NOT use both RS-232 and IP for control simultaneously. Using both control methods at the same time will affect control reliability.

Connection Settings:

Baud rate: 9600 • Data bits: 8 • Parity: None • Stop bits: 1

DB-9 Jack Pinout:

Pin 2	TXD Transmit Data
Pin 3	RXD Receive Data
Pin 5	GND Ground

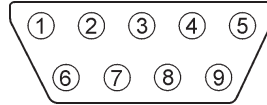

CONTROLLING MULTIPLE AD-8x UNITS - USING RS-232

For RS-232 control, each AD-8x must have it's own RS-232 connection to an RTI control processor.

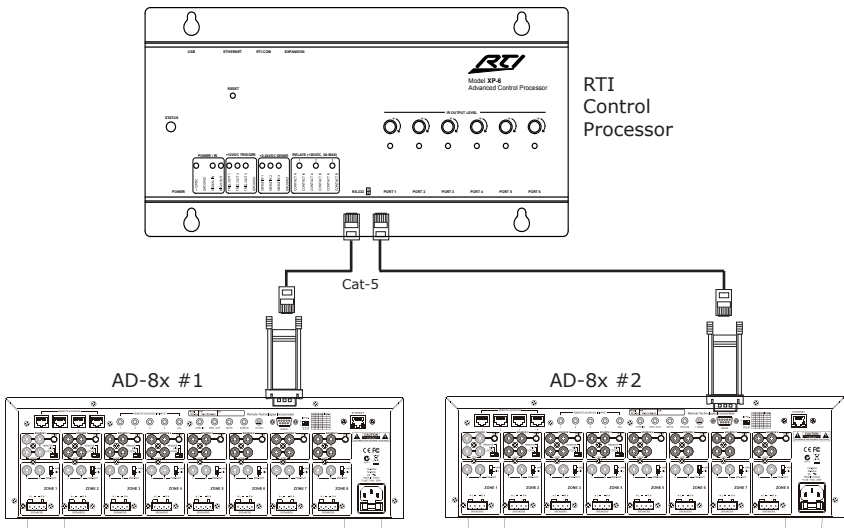

CHAPTER 3 | INSTALLATION AND OPERATION

IP CONTROL OF AD-8x UNITS - ETHERNET

The built-in Ethernet port allows convenient control of one or more AD-8x units (maximum 8) using IP via an Ethernet network (LAN) from an RTI XP processor. Configuration of the AD-8x networking is done through a web interface which is accessible through any web browser (See "CONFIGURING THE AD-8X USING THE WEB INTERFACE" section of this guide).

NOTES: For IP control:

- DO NOT use both RS-232 and IP for control simultaneously. Using both control methods at the same time will affect control reliability.
- The RTI control system must have a two-way driver running on the XP processor.
- The RTI control system and each AD-8x must be connected to the same Ethernet network (LAN).

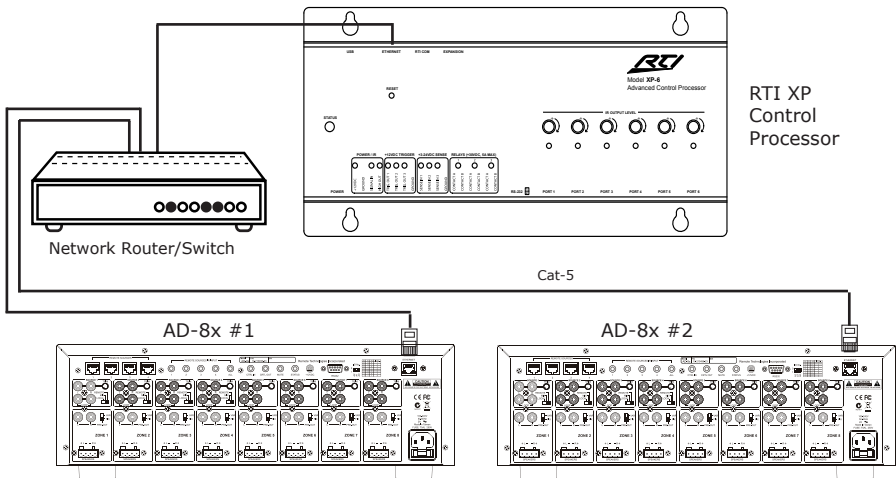

CHAPTER 3 | INSTALLATION AND OPERATION

AD-8X CONNECTION DIAGRAM

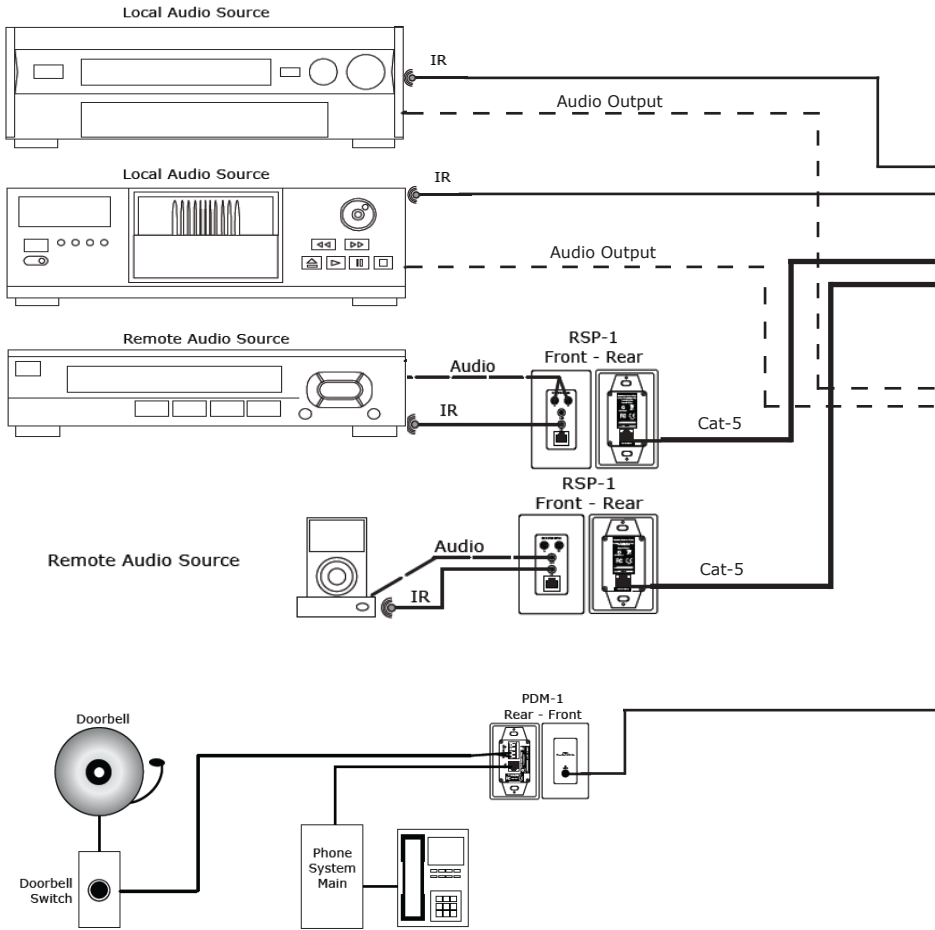

ZM-24 Transceiver Module

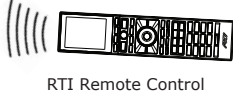

RTI Remote Control

RTI CB8

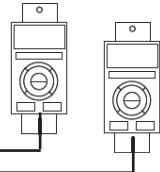
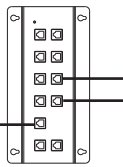

RTI Keypads

XP-6

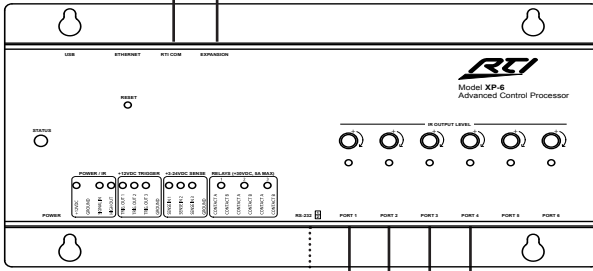

To (LAN)
(For IP control, refer to previous section.)

RS-232 RJ45>DB9 Adapter

AD-8x

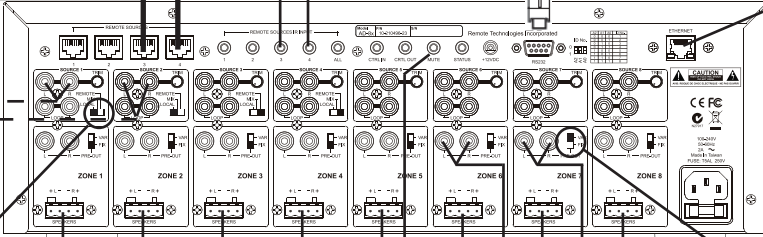

Local/Remote Source switch

Audio Zone 1 Audio Zone 2 Audio Zone 3 Audio Zone 4 Audio Zone 5 Audio Zone 6 Audio Zone 7 Audio Zone 8

Pre-Out Cable

Pre-Out Cable

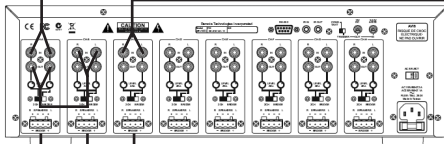

RTI CP-1650 Amplifier

Audio Zone 6 Audio Zone 6 Audio Zone 7

The PRE-OUT can be set to either fixed (FIX) or variable (VAR). The PRE-OUT level will ramp up and down with the corresponding zones volume control when set to the variable (VAR) position.

CHAPTER 3 | INSTALLATION AND OPERATION

CONFIGURING THE AD-8X USING THE WEB INTERFACE

The AD-8x web interface is accessible via a standard web browser (Internet Explorer®, Firefox®, Safari® etc) on a PC, tablet or smartphone.

The web interface is used for:

- Configuring networking - IP address etc.
- Testing output zones - Each zone can have it's current source, volume, power and mute status adjusted during the setup process.
- Zone grouping - Output zones may be assigned to a "group", allowing multiple zones to be controlled simultaneously as a single output zone.

ADDING THE AD-8X TO THE ETHERNET NETWORK

Wire the AD-8x to the Ethernet network using Cat-5 cable with the RJ45 termination and power the unit on. The network router will assign an IP address to the Ad-8x automatically and allow it to join the network.

- The AD-8x is set to use DHCP by default.
- Router must have DHCP enabled.

ACCESSING THE WEB INTERFACE

To access the web interface, first determine the IP address that was assigned to the AD-8x by the network router which can be found by looking for UPNP devices on the network.

NOTE: If using Windows XP, you may need to enable viewing of UPNP devices and "Windows Discovery".

- Click on My Network Places
- If UPNP devices are not displayed, under Network Tasks, click on "Show icons for networked UPNP devices". Click yes to allow the installation wizard.

To view UPNP devices on the network, go to the "network" area in your version of Windows.

- In the "Computer" tab under the Start Menu.
- Click on "Network".
- On the right side window, scroll down to "Other Devices".
- Find the AD-8x in the list of devices and double click on the icon to open the web interface.

OR

- The AD-8x icon will display the IP address it is using. Open a web browser on your PC, tablet or smartphone and type the IP address into the browser address bar.

Example: <http://192.168.0.15>

CHAPTER 3 | INSTALLATION AND OPERATION

WEB INTERFACE - STATUS PAGE

After entering the IP address into the web browser and hitting enter, the Status Page will be the first page displayed. The information includes the AD-8x name, firmware version, IP address and MAC address.

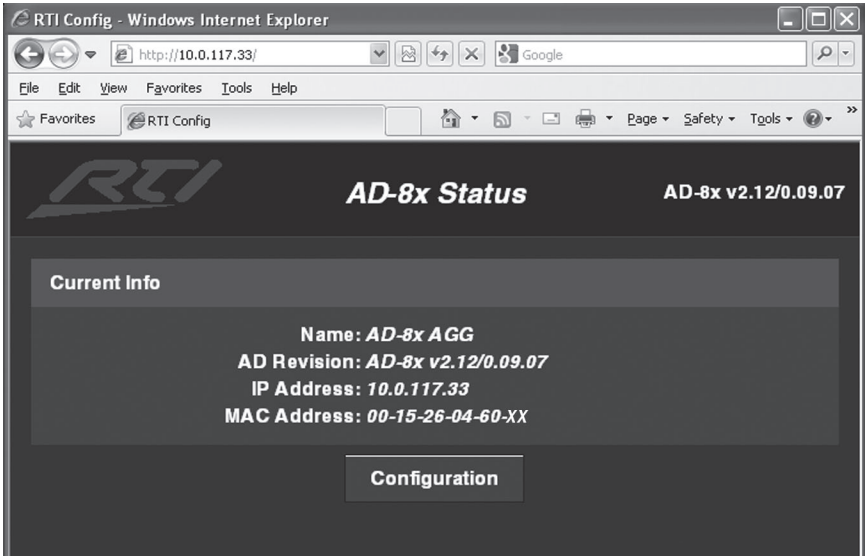

WEB INTERFACE - LOGIN

To configure the AD-8x settings, click on the "Configuration" button to login.

NOTE: The default password is: rti

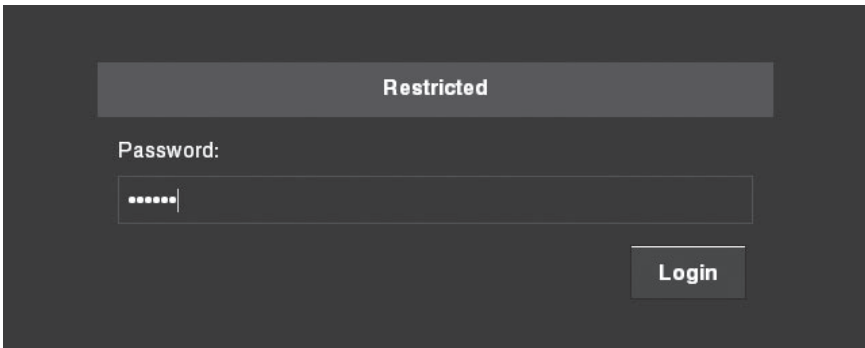

CHAPTER 3 | INSTALLATION AND OPERATION

WEB INTERFACE - NETWORK CONFIGURATION PAGE

Upon logging into the web interface the Network Configuration page will be displayed. You can also reach this page by clicking "Network" tab at the bottom of the web interface.

IP ADDRESS CONFIGURATION

IMPORTANT NOTES:

- Setting a static IP address is NOT necessary and is discouraged. The RTI two-way driver uses the UPNP name of the AD-8x to find it on the network so a static IP is unnecessary.
- Setting a static IP address and clicking "Update Settings" will cause the web interface to no longer be displayed in your web browser. Enter the new static IP address into your web browser address bar to access the web interface again.

To set the static IP address:

1. Select **Address Type** (set to DHCP by default): click this button and select "Static IP" from the drop down list.
2. Enter **Static IP Address**: Enter the static IP address.
3. Enter **Subnet Mask**: Enter the network subnet used by the AD-8x and RTI XP processor.
4. Enter **Default Gateway**: Enter the IP address of the network gateway.
5. Click on the "Update Settings" button to save these settings.

NOTE: To manually reset the AD-8x to DHCP

If the wrong IP address scheme is used during the static IP setup process, the AD-8x will not be accessible via the network. If this happens, the AD-8x web interface will not be available to make corrections and control via IP will not be possible.

To correct this, the AD-8x will need to be manually set back to DHCP using an RS-232 string so that it may rejoin the network, and allow the web interface to be used again.

Steps to reset IP Address Type to DHCP:

1. Connect a serial cable between your RTI control processor (or PC) and the AD-8x. (See "RS-232 CONTROL OF AD-8x" for cable requirements).
2. Send this RS-232 string followed by a carriage return: `^rti dhcp`
 - NOTE: There is a **space** between the "i" and the "d".
 - The string with carriage return using Integration Designer is: `^rti dhcp\r`
3. Follow the steps in the "ACCESSING THE WEB INTERFACE" section to gain access to the web interface again.

NETWORK IDENTIFICATION

This section allows you to change the name of the device as it shows up on the network and list of UPNP devices.

1. Unit Name: Enter a new AD-8x name
2. Click on the "Update Settings" button to save these settings.

CHAPTER 3 | INSTALLATION AND OPERATION

WEB INTERFACE - NETWORK PAGE

RTI **AD-8x Network Config** AD-8x v2.12/0.09.07

Current Info

Name: *AD-8x AGG*
AD Revision: *AD-8x v2.12/0.09.07*
IP Address: *10.0.117.33*
MAC Address: *00-15-26-04-60-XX*

IP Address

Address Type: **DHCP** ▼

Static IP Address: 10 . 0 . 117 . 33

Subnet Mask: 255 . 255 . 0 . 0

Default Gateway: 10 . 0 . 0 . 1

Update Settings

Network Identification

Unit Name: **AD-8x AGG**

Update Settings

Network Zones Groups

CHAPTER 3 | INSTALLATION AND OPERATION

WEB INTERFACE - ZONES PAGE

The Zones page of the web interface is used during AD-8x setup, allowing you to adjust the source, power, mute, volume and the assigned group from a device with a web browser such as a PC, tablet or smartphone.

View this page by clicking "Zones" tab at the bottom of the web interface.

ZONE CONFIGURATION

Click the "+" next to the zone you wish to configure and test.

- **Sources:** Select the audio input source for this zone.
- **Power:** Click on this button to power the zone on and off.
- **Mute:** Click on this button to mute the zone on and off.
- **Volume:** Current volume level is displayed on volume slider bar. To adjust the volume level, use the raise and lower buttons or click on the volume slider bar to jump to a level.

CAUTION: Clicking on the volume level bar will cause the volume to JUMP to that level - be VERY careful where you click to prevent accidentally raising the volume to a high level.

- **Group:** Select the group that this zone will be a member of, or select "None" if this zone isn't going to be grouped with other zones. Grouped zones will be controlled together, allowing volume levels to be adjusted simultaneously in multiple zones.

NOTE: Zones can only be a member of one group.

CHAPTER 3 | INSTALLATION AND OPERATION**WEB INTERFACE - ZONES PAGE**

RTI **AD-8x Zones** **AD-8x v2.12/0.09.07**

- Zone 1

Source:

1 2 3 4 5 6 7 8

Power:

On

Mute:

Off

Volume (dB):

-47

< >

Group:

None 1 2 3 4 5 6 7 8

+ Zone 2

+ Zone 3

+ Zone 4

+ Zone 5

+ Zone 6

+ Zone 7

+ Zone 8

Network Zones Groups

WEB INTERFACE - GROUPS PAGE

The Groups page of the web interface is used during AD-8x setup, allowing you to adjust power, mute and volume of each group from a device with a web browser such as a PC, tablet or smartphone.

View this page by clicking "Groups" tab at the bottom of the web interface.

GROUPS CONFIGURATION

Grouped zones will be controlled together, allowing volume levels to be adjusted simultaneously in multiple zones, such as in an adjoining kitchen/family room. The group names are followed by the zones that are members of each group.

Click the "+" next to the group you wish to configure.

- **Power:** Click on this button to power the grouped zones on and off.
- **Mute:** Click on this button to mute the grouped zones on and off.
- **Volume:** To adjust the volume level of a group, use the raise and lower buttons.

NOTES:

- Volume will raise until the maximum limit is reached in any zone in the group. At that point the other zones in the group will stop raising the volume level.
- Volume will lower until the minimum limit is reached in any zone in the group. At that point the other zones in the group will stop lowering the volume level.

WEB INTERFACE - GROUPS PAGE

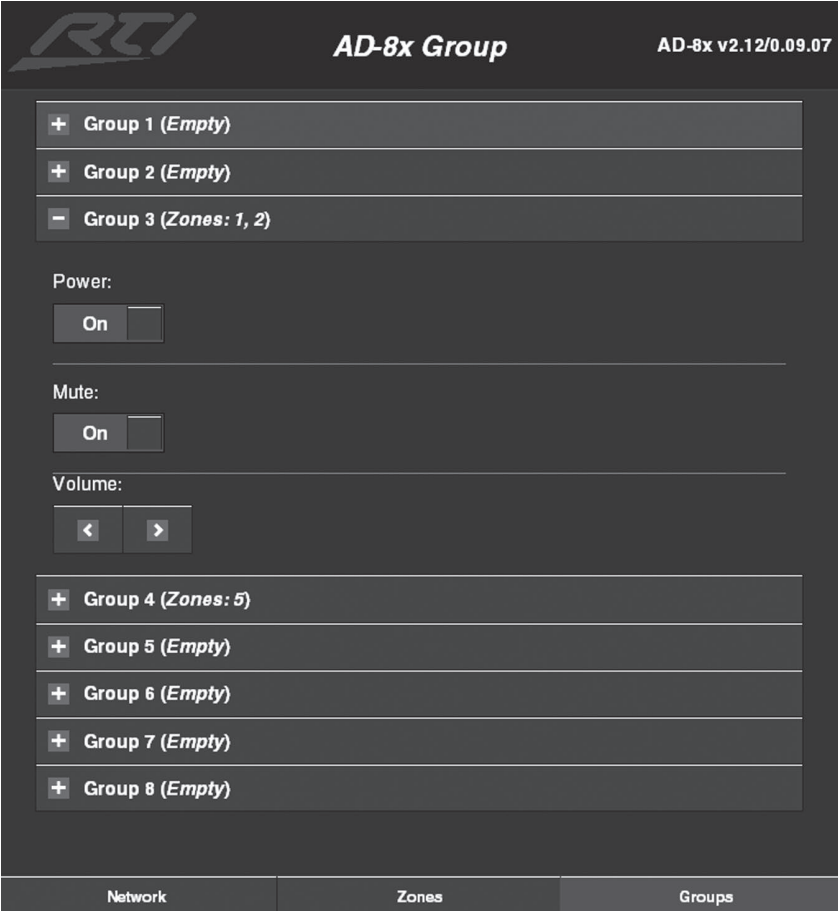

The screenshot displays the RTI AD-8x Group web interface. At the top left is the RTI logo, and at the top right is the text "AD-8x Group" and "AD-8x v2.12/0.09.07". The main content area features a list of groups:

- + Group 1 (Empty)
- + Group 2 (Empty)
- Group 3 (Zones: 1, 2)

Below the list are control options:

Power: On

Mute: On

Volume:

At the bottom, there is a navigation bar with three tabs: "Network", "Zones", and "Groups".

CHAPTER 4 | SPECIFICATIONS

GENERAL

Power Supply	115VAC or 230VAC (switchable), 230W
Mounting	Rack mount or free standing
Dimensions (W x H x D)	16.9" (430mm) x 5.3" (133mm) x 14.5" (369mm)
Weight	23.4 lb. (10.6kg)
Warranty	One Year (Parts & Labor)

CONTROL & CONNECTIONS

Output Zones	Eight zones, two channels each
Pre-Outputs	Eight, RCA jack pairs (switchable between fixed or variable)
Audio Source Inputs (Local)	Eight, 8 RCA jack pairs
Audio Source Inputs (Remote)	Four, RJ-45 jacks
Loop Outputs	Eight, 8 RCA jack pairs
Control Input	One, 3.5mm jack, compatible with industry standard IR repeaters and receivers
Control Output	One, 3.5mm jack, compatible with industry standard IR repeaters and receivers
Remote Source IR Inputs	Five, Four discrete, One universal (All), 3.5mm jacks
Mute Input	One, 3.5mm jack Phone Input Sensitivity: AC25V-AC100V 20Hz Doorbell Sensitivity: AC/DC 3-12VDC
Trigger Output (Status Jack)	One, 12VDC, 15mA max
+12VDC Voltage Output	One, 12VDC, 500mA max
RS-232 Port	One, Bi-directional DB-9
Ethernet Port	One, 10/100Base-T, RJ45 Connection
Unit ID Numbers	1-8, Set using 3 switches

All specifications subject to change without notice.

CHAPTER 4 | SPECIFICATIONS

AUDIO

Total Output Zones	Eight zones, two channels each (either 4 ohm or 8 ohm speakers may be connected to the zone outputs)
Rated Power / Channel	>20 Watts, 20Hz to 20KHz (RMS, 2 channels driven into 8 ohms)
Power / Channel	>25 Watts @ 1KHz (RMS, 2 channels driven into 8 ohms)
Total Harmonic Distortion @20W/8ohm	0.5%
Total Harmonic Distortion @1W/8ohm	<0.05%
S/N @ Rated power, IEC A-wtd, Source input shorted	92dB (mute +1)
Frequency Response 20Hz to 20KHz @ 1W/8ohms	1.5+/-0.5dB
Input Overload	2.5V
Input Impedance	>22K ohms
Channel Separation @1KHz	>60dB
Crosstalk Between Sources @ Rated Power /1KHz	>75dB
Crosstalk Between Zones @ Rated Power /1KHz	80dB
Treble Control @10KHz	10dB +/- 0.5dB
Bass Control Range @100Hz	10dB +/- 0.5dB

All specifications subject to change without notice.

CHAPTER 5 | TROUBLESHOOTING

If you are having problems with your AD-8x Audio Distribution System, please read the information below before contacting technical support.

If you continue to have problems, see Chapter 6 for more information on contacting RTI technical support.

AD-8x DOES NOT FUNCTION PROPERLY

Symptom: No sound.

Possible Causes:

- AC power unplugged > Check AC cable and outlet.
- Main power switch not on > Is main power light on?
- Outlet has no power > Verify outlet has power.
- Blown fuse > Check main fuse.
- Mute jack > Is mute jack in active mode?

Symptom: No sound from individual zones.

Possible Causes:

- Faulty wiring > Verify all wiring.
- Zone output not on > Are zone output light(s) on?

Symptom: No sound via remote source wallplate.

Possible Causes:

- Faulty wiring > Verify all wiring & terminations.
- Verify source output > Make sure source has audio output.

Symptom: No IR control via remote source wallplate.

Possible Causes:

- Faulty wiring > Verify all wiring & terminations.
- IR signal level > Adjust IR signal going into AD-8x.
- IR emitter > Verify IR emitter is working.
- IR emitter placement > Verify emitter is properly placed.

Symptom: No IR control of AD-8x.

Possible Causes:

- Faulty wiring > Jack is 1/8" mono, tip = IR+, ring=Gnd.
- IR signal level > Adjust IR signal going into AD-8x.
- CTRL IN > Verify connection is to CTRL IN

CHAPTER 5 | TROUBLESHOOTING

Symptom: No RS-232 control of AD-8x.

Possible Causes:

- Faulty wiring > Check RS-232 pinout.
- Incorrect string > Verify string from manual.
- No carriage return > String requires carriage return.

Symptom: Distortion when using RSP-1.

Possible Causes:

- IR output on the RTI control processor > Reduce IR output from RTI control processor.

CHAPTER 6 | SERVICE AND SUPPORT

For news about the latest updates, new product information, and new accessories, please visit our web site at:

www.rticorp.com

CONTACTING RTI

For general info, you can contact RTI at:

Tel. (952) 253-3100

Fax (952) 253-3131

info@rticorp.com

RTI TECHNICAL SUPPORT

At RTI, customer service and satisfaction is an utmost priority. If you are encountering any problems or have a question about your RTI product, please contact RTI Technical Support for assistance.

RTI provides technical support by telephone, fax or e-mail. For the highest quality service, please have the following information ready, or provide it in your fax or e-mail.

- Your Name
- Company Name
- Telephone Number
- E-mail Address
- Product model and serial number (if applicable)

If you are having a problem with hardware, please note the equipment in your system, a description of the problem, and any troubleshooting you have already tried.

If you are having a problem with software, please note what version you have installed, the operating system on your PC, a description of the problem, and any troubleshooting you have already tried.

If you are calling about a software or programming question or problem, please be at you computer when you place your call. This will considerably speed up the troubleshooting process.

For technical support or assistance with your AD-8x, software, or accessories, contact RTI at:

(952) 253-3137

support@rticorp.com

www.rticorp.com

For questions regarding service or repair of your AD-8x, contact RTI at:

(952) 253-3136

service@rticorp.com

www.rticorp.com

Please do not return products to RTI without return authorization.

CHAPTER 6 | SERVICE AND SUPPORT

Shipment of AD-8x for Service

RTI will pay all labor and material expenses for all repairs covered by this product's warranty. If necessary repairs are not covered by warranty, or if a unit is examined which is not in need of repair, you may be charged for the repairs or examination.

If it is necessary to ship the AD-8x for service:

- Please pack it securely (we suggest that it be insured).
- Do not include accessories such as power cords or manuals unless instructed to do so.

You must pay any shipping charges incurred in getting your AD-8x to RTI. RTI will pay reasonable return shipping charges via a carrier of our choice to any destination within the United States if the repairs are covered under warranty.

A copy of the original dated sales receipt must be provided whenever warranty service is required. You will need this receipt to establish the date of purchase.

INDEX

Contents	7
Description	12
AD-8x Front Panel	13
AD-8x Rear Panel	14
RSP-1	16
PDM-1	17
Disclaimer	6
Features.....	12
Federal Communications Commission Notice	3
Installation/Operation	18
Connection Options	19
Connections Diagram	26
Control (IR/RS-232)	24
Mounting/Power	18
Important Notes.....	9
Limited Warranty	6
Product Contents	10
Safety Suggestions	4
Service and Support	43
Specifications.....	37
Troubleshooting.....	40
Welcome	9

NOTES

NOTES

It's Under Control®



Remote Technologies Incorporated
5775 12th Avenue East, Suite 180
Shakopee, MN 55379
Tel: 952-253-3100
Fax: 952-253-3131
www.rticorp.com